

Surface Mount Power Splitter/Combiner

LRPQ-700J+ LRPQ-700J

2 Way-90° 50Ω 500 to 700 MHz



Maximum Ratings

Operating Temperature	-40°C to 85°C
Storage Temperature	-55°C to 100°C
Power Input (as a splitter)	1W max.

Pin Connections

SUM PORT	6
PORT 1 (0°)	4
PORT 2 (+90°)	1
GROUND	2,5
50 OHM TERM EXTERNAL	3

Outline Drawing

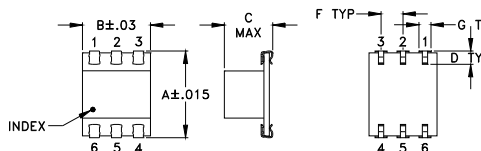

PCB Land Pattern

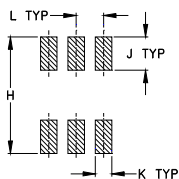

Suggested Layout,
Tolerance to be within ±.002

Outline Dimensions (inch/mm)

A	B	C	D	E	F	G	
.390	.31	.225	.060	--	.100	.045	
9.91	7.87	5.72	1.52	--	2.54	1.14	
H	J	K	L	M			wt
.420	.120	.060	.100	--			grams
10.67	3.05	1.52	2.54	--			0.50

Demo Board MCL P/N: TB-226 Suggested PCB Layout (PL-140)

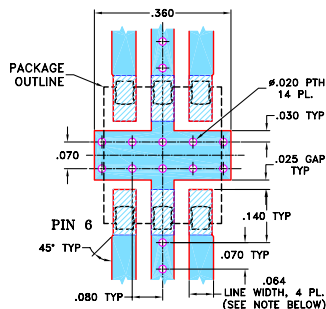

- NOTE:**
- TRACE WIDTH IS SHOWN FOR ROGERS RO4350B WITH DIELECTRIC THICKNESS .030" ± .002"; COPPER: 1/2 OZ. EACH SIDE. FOR OTHER MATERIALS TRACE WIDTH MAY NEED TO BE MODIFIED.
 - BOTTOM SIDE OF THE PCB IS CONTINUOUS GROUND PLANE.
-

Features

- low insertion loss, 0.2 dB typ.
- excellent phase unbalance 1 deg. typ.
- aqueous washable

Applications

- modulators
- UHF
- signal processing
- balanced amplifiers
- instrumentation

CASE STYLE: QQQ569
PRICE: \$9.95 ea. QTY (1-9)

+ RoHS compliant in accordance
with EU Directive (2002/95/EC)

The +Suffix identifies RoHS Compliance. See our web site
for RoHS Compliance methodologies and qualifications.

Electrical Specifications

FREQ. RANGE (MHz)	ISOLATION (dB)	INSERTION LOSS (dB) Avg. of Coupled Outputs less 3 dB	PHASE UNBALANCE (Degrees)	AMPLITUDE UNBALANCE (dB)
f_L - f_U	Typ. Min.	Typ. Max.	Max.	Max.
500-700	23 18	0.2 0.6	3	1.8

LRPQ units have bottom barrier ground plane insulated with glass barrier.

Typical Performance Data

Frequency (MHz)	Insertion Loss (dB)		Amplitude Unbalance (dB)	Isolation (dB)	Phase Unbalance (deg.)	VSWR S	VSWR 1	VSWR 2
	S-1	S-2						
500.00	2.51	3.96	1.45	25.13	89.53	1.13	1.09	1.13
510.00	2.57	3.86	1.28	25.04	89.47	1.13	1.10	1.13
520.00	2.63	3.77	1.14	24.93	89.55	1.14	1.10	1.13
535.00	2.72	3.63	0.92	24.75	89.57	1.14	1.10	1.14
550.00	2.84	3.54	0.70	24.62	89.56	1.15	1.11	1.15
565.00	3.00	3.47	0.47	24.54	89.51	1.16	1.12	1.15
580.00	3.05	3.35	0.30	24.31	89.40	1.16	1.12	1.16
595.00	3.14	3.24	0.11	24.14	89.62	1.17	1.13	1.17
610.00	3.23	3.16	0.07	23.97	89.60	1.18	1.13	1.17
625.00	3.33	3.07	0.26	23.77	89.67	1.19	1.14	1.18
640.00	3.41	2.97	0.44	23.55	89.64	1.20	1.14	1.19
660.00	3.56	2.90	0.66	23.32	89.71	1.21	1.15	1.20
680.00	3.68	2.80	0.88	23.03	89.71	1.22	1.16	1.21
690.00	3.74	2.77	0.97	22.91	89.71	1.22	1.16	1.21
700.00	3.83	2.76	1.07	22.79	89.73	1.23	1.17	1.22

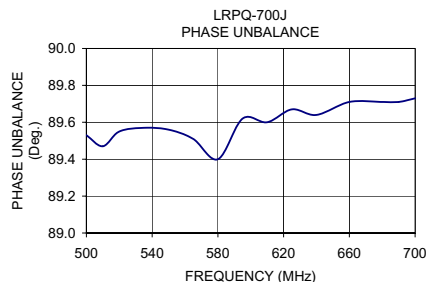
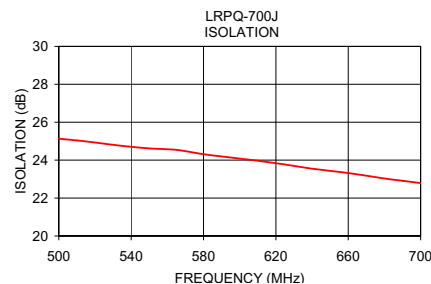
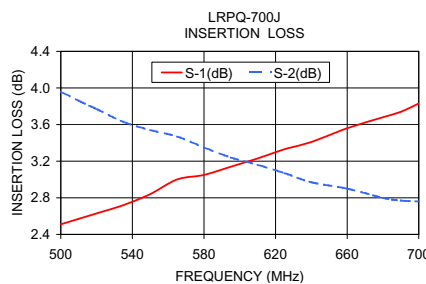

electrical schematic

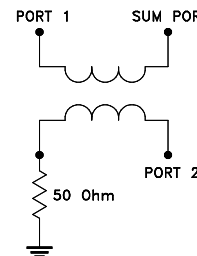

Mini-Circuits®
ISO 9001 ISO 14001 AS 9100 CERTIFIED

minicircuits.com

P.O. Box 350166, Brooklyn, New York 11235-0003 (718) 934-4500 Fax (718) 332-4661 For detailed performance specs & shopping online see Mini-Circuits web site



The Design Engineers Search Engine Provides ACTUAL Data Instantly From MINI-CIRCUITS At: www.minicircuits.com

IF/RF MICROWAVE COMPONENTS

REV. B
M105445
LRPQ-700J
HY/TD/CP
070425