

Wide Band 1950 to 2700 MHz

Features

- Linear Tuning characteristics
- Low Pushing
- Aqueous washable

Applications

- Wireless communication
- Test equipment
- Cable TV

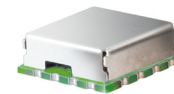

CASE STYLE: CK605
PRICE: \$ 24.95 ea. QTY (5-49)

+ RoHS compliant in accordance with EU Directive (2002/95/EC)

The +Suffix has been added in order to identify RoHS Compliance. See our web site for RoHS Compliance methodologies and qualifications.

Electrical Specifications

MODEL NO.	FREQ. (MHz)		POWER OUTPUT (dBm)	PHASE NOISE dBc/Hz SSB at offset frequencies, kHz				TUNING				NON HARMONIC SPURIOUS (dBc)	HARMONICS (dBc)		PULLING pk-pk @ 12 dBr (MHz)	PUSHING (MHz/V)	DC OPERATING POWER			
	Min.	Max.		Typ.	1	10	100	1000	VOLTAGE RANGE (V)	SENSI- TIVITY (MHz/V)	PORT CAP (pF)		3 dB MODULATION BANDWIDTH (MHz)	Typ.			Typ.	Typ.	Typ.	Vcc (volts)
ROS-2700-819+	1950	2700	+8.5	-64	-90	-112	-132	0.5	10	91	156	20	340	-90	-27	-12	14	4	8.5	29

Pin Connections

RF OUT	10
VCC	14
V-TUNE	2
GROUND	1,3,4,5,6,7,8,9,11,12,13,15,16

Maximum Ratings

Operating Temperature	-55°C to 85°C
Storage Temperature	-55°C to 100°C
Absolute Max. Supply Voltage (Vcc)	10V
Absolute Max. Tuning Voltage (Vtune)	12V
All specifications	50 ohm system

Outline Drawing

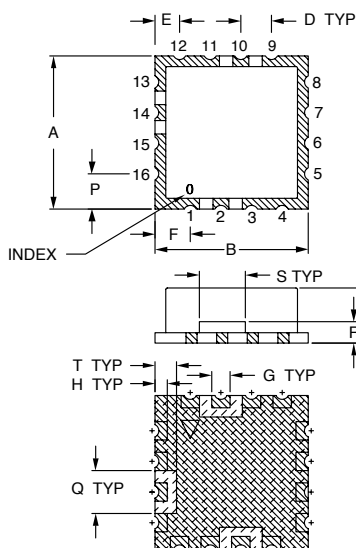

PCB Land Pattern

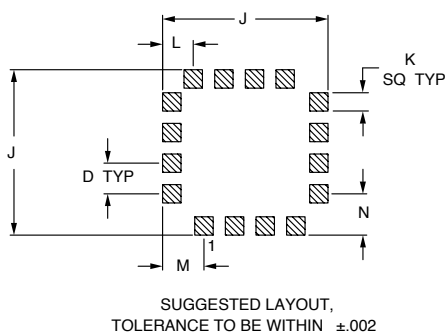

Demo Board MCL P/N: TB-10 Suggested PCB Layout (PL-012)

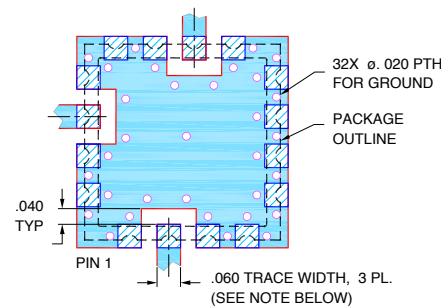

- NOTES:
1. TRACE WIDTH IS SHOWN FOR RF4 WITH DIELECTRIC THICKNESS .030" ± .002"; COPPER: 1/2 OZ. EACH SIDE. FOR OTHER MATERIALS TRACE WIDTH MAY NEED TO BE MODIFIED.
 2. BOTTOM SIDE OF THE PCB IS CONTINUOUS GROUND PLANE.
- DENOTES PCB COPPER LAYOUT WITH SMOBC (SOLDER MASK OVER BARE COPPER)
 - DENOTES COPPER LAND PATTERN FREE OF SOLDER MASK

Outline Dimensions (inch/mm)

A	B	C	D	E	F	G	H	J	K	L	M	N	P	Q	R	S	T	wt.
.500	.500	.180	.100	.080	.115	.060	.040	.540	.060	.100	.135	.135	.115	.140	.070	.150	.070	grams
12.70	12.70	4.57	2.54	2.03	2.92	1.52	1.02	13.72	1.52	2.54	3.43	3.43	2.92	3.56	1.78	3.81	1.78	1.0



P.O. Box 350166, Brooklyn, New York 11235-0003 (718) 934-4500 Fax (718) 332-4661 For detailed performance specs & shopping online see Mini-Circuits web site



The Design Engineers Search Engine Provides ACTUAL Data Instantly From MINI-CIRCUITS At: www.minicircuits.com

RF/IF MICROWAVE COMPONENTS



REV. OR
M105224
EDR-7291MP
ROS-2700-819+
RAV
080213
Page 1 of 2

Performance Data & Curves*

ROS-2700-819+

V TUNE	TUNE SENS (MHz/V)	FREQUENCY (MHz)			POWER OUTPUT (dBm)			Icc (mA)	HARMONICS (dBc)			FREQ. PUSH (MHz/V)	FREQ. PULL (MHz)	PHASE NOISE (dBc/Hz) at offsets				FREQ OFFSET (KHz)	PHASE NOISE at 2325 MHz (dBc/Hz)
		-55°C	+25°C	+85°C	-55°C	+25°C	+85°C		F2	F3	F4			1kHz	10kHz	100kHz	1MHz		
0.00	143.75	1674.9	1653.4	1630.3	9.75	9.67	8.93	22.69	-19.8	-40.7	-38.1	1.69	17.05	-65.5	-89.3	-109.9	-129.9	1.0	-66.39
1.00	136.86	1821.5	1795.5	1769.9	9.09	9.19	8.94	22.98	-20.5	-31.5	-33.1	3.77	22.07	-68.1	-90.8	-111.6	-131.6	2.0	-72.09
1.50	136.16	1893.0	1863.9	1836.7	9.09	9.04	8.86	23.15	-22.7	-29.1	-32.3	4.58	30.94	-69.4	-93.5	-113.3	-133.5	3.5	-77.71
2.00	135.50	1963.7	1932.0	1903.4	9.02	8.98	8.84	23.34	-25.4	-27.8	-32.2	4.50	17.20	-66.0	-93.1	-114.2	-134.3	6.0	-83.57
2.50	144.75	2033.2	1999.7	1971.1	8.94	8.91	8.70	23.48	-28.4	-26.9	-34.7	4.18	16.50	-64.2	-90.0	-111.3	-132.1	8.5	-88.17
3.00	156.15	2113.2	2072.1	2040.4	9.09	8.83	8.54	23.60	-32.4	-27.2	-37.1	3.61	13.78	-63.2	-90.8	-111.7	-131.9	10.0	-91.86
3.50	148.76	2193.3	2150.2	2115.5	9.34	8.89	8.52	23.82	-40.3	-27.3	-33.5	4.65	8.96	-63.8	-88.8	-110.0	-130.5	20.8	-96.77
4.00	144.76	2267.0	2224.6	2189.9	9.34	8.88	8.51	23.97	-46.2	-26.6	-32.2	6.02	9.38	-66.1	-90.7	-112.0	-132.2	35.5	-101.47
4.50	140.00	2337.6	2297.0	2263.3	9.29	8.82	8.45	24.07	-41.6	-26.5	-32.4	5.99	7.45	-63.3	-89.0	-110.3	-130.9	60.7	-106.08
5.00	132.73	2405.5	2367.0	2335.5	9.08	8.77	8.42	24.10	-36.5	-25.7	-35.3	5.62	11.77	-66.9	-91.8	-113.0	-133.3	86.7	-109.39
5.50	125.49	2469.8	2433.3	2404.6	8.83	8.76	8.27	24.11	-30.7	-25.1	-36.4	4.59	21.74	-67.8	-91.4	-113.2	-133.4	100.0	-113.58
6.00	116.90	2528.8	2496.1	2468.9	8.72	8.73	8.12	24.14	-27.1	-26.0	-37.7	3.83	21.67	-64.6	-89.9	-111.8	-132.4	148.1	-113.98
6.50	105.61	2583.9	2554.5	2526.8	8.72	8.57	8.17	24.15	-25.2	-26.4	-35.5	3.46	19.66	-63.8	-90.0	-111.3	-132.0	177.0	-115.52
7.00	95.52	2636.5	2607.3	2579.9	8.54	8.44	8.20	24.10	-23.2	-29.2	-33.2	3.48	12.29	-62.1	-89.6	-112.0	-132.5	211.6	-117.04
7.50	90.92	2683.8	2655.1	2630.0	8.45	8.44	8.00	24.11	-22.1	-30.0	-33.1	3.32	13.20	-63.6	-90.9	-113.3	-134.0	302.4	-120.37
8.00	80.32	2727.2	2700.5	2674.1	8.44	8.23	8.11	24.12	-21.2	-29.8	-36.2	3.46	16.27	-64.2	-91.3	-113.8	-134.7	361.5	-121.92
8.50	78.63	2768.7	2740.7	2716.3	8.15	8.25	7.98	24.10	-20.5	-29.7	-39.3	3.48	19.10	-62.5	-90.6	-112.4	-133.1	507.5	-124.74
9.00	68.75	2805.0	2780.0	2754.1	8.12	7.99	7.96	24.12	-19.4	-30.0	-42.1	3.58	18.01	-64.2	-92.4	-115.0	-135.7	606.7	-126.50
9.50	69.33	2841.6	2814.4	2790.6	7.92	8.02	7.74	24.10	-19.0	-28.9	-46.0	3.53	9.51	-63.8	-91.6	-114.3	-135.1	851.6	-129.42
10.00	61.16	2873.8	2849.1	2823.1	7.86	7.80	7.78	24.10	-18.4	-27.8	-48.2	3.74	19.92	-62.2	-92.1	-114.5	-135.2	1000.0	-133.00

*at 25°C unless mentioned otherwise

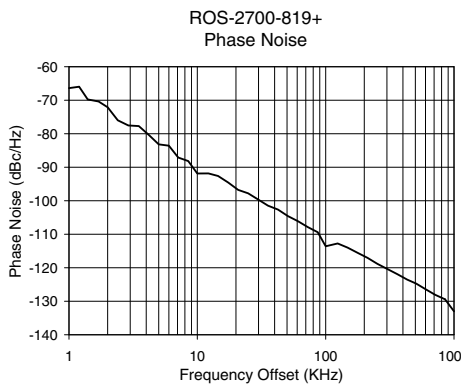
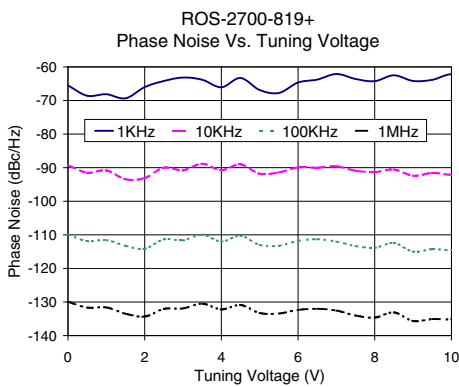
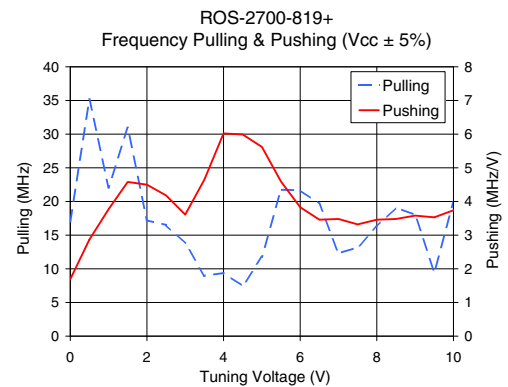
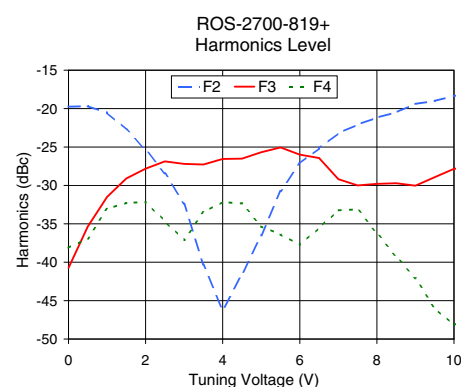
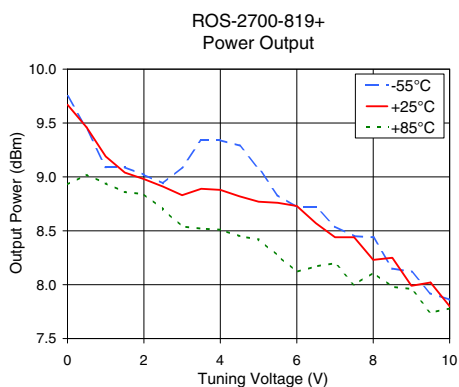
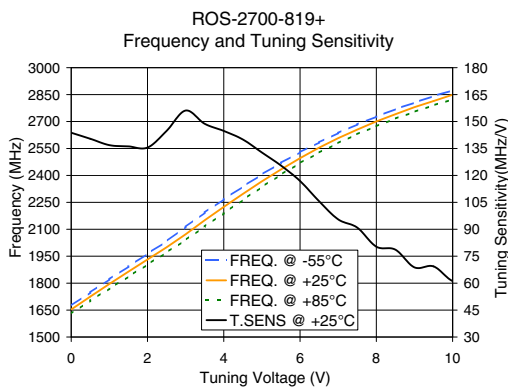

P.O. Box 350166, Brooklyn, New York 11235-0003 (718) 934-4500 Fax (718) 332-4661 For detailed performance specs & shopping online see Mini-Circuits web site



The Design Engineers Search Engine Provides ACTUAL Data Instantly From MINI-CIRCUITS At: www.minicircuits.com

RF/IF MICROWAVE COMPONENTS