

Typical Applications

- CDMA/Cellular Bypass LNA
- CDMA/Cellular Bypass Driver Amplifier
- General Purpose Amplification
- Commercial and Consumer Systems

Product Description

The RF2369 is a switchable low noise amplifier with a very high dynamic range designed for digital cellular applications. The device functions as an outstanding front end low noise amplifier. When used as an LNA, the bias current can be set externally. When used as a PA driver, the IC can operate directly from a single cell Li-ion battery and includes a power down feature that can be used to completely turn off the device. The IC is featured in a standard SOT 6-lead package.

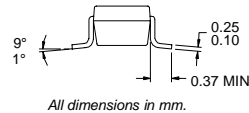
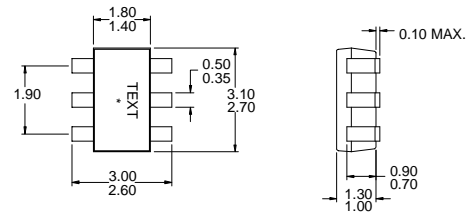

4
GENERAL PURPOSE AMPLIFIERS

Optimum Technology Matching® Applied

- Si BJT GaAs HBT GaAs MESFET
 Si Bi-CMOS SiGe HBT Si CMOS

Package Style: SOT 6-Lead

- Features
- Low Noise and High Intercept Point
 - Adjustable Bias Current
 - LNA Bypass Loss is +2dB
 - 150MHz to 2500MHz Operation
 - Meets IMD Tests with Two Gain States/ Single Logic Control Line

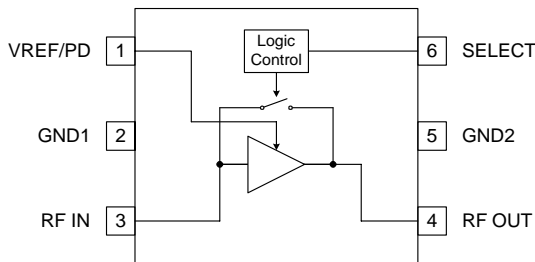

Functional Block Diagram

Ordering Information

RF2369	3V Low Noise Amplifier/ 3V PA Driver Amplifier
RF2369 PCBA	Fully Assembled Evaluation Board (LNA)

RF Micro Devices, Inc.
7625 Thorndike Road
Greensboro, NC 27409, USA

Tel (336) 664 1233
Fax (336) 664 0454
<http://www.rfmd.com>

Absolute Maximum Ratings

Parameter	Rating	Unit
Supply Voltage	-0.5 to +8.0	V _{DC}
Input RF Level	+10	dBm
Operating Ambient Temperature	-40 to +85	°C
Storage Temperature	-40 to +150	°C





Caution! ESD sensitive device.

RF Micro Devices believes the furnished information is correct and accurate at the time of this printing. However, RF Micro Devices reserves the right to make changes to its products without notice. RF Micro Devices does not assume responsibility for the use of the described product(s).

Parameter	Specification			Unit	Condition
	Min.	Typ.	Max.		
Overall					T _{AMB} =25°C, V _{CC} =3.0V
Frequency Range	150	824 to 894	2500	MHz	
Cellular Low Noise Amplifier					
Frequency	869		894	MHz	Gain Select<0.8V, V _{PD} /V _{REF} =3V
<i>HIGH GAIN MODE</i>					
Gain	14.0	15.5	17.0	dB	
Noise Figure		1.6	2.0	dB	
Input IP3	9.0	11.5		dBm	
Input VSWR			2:1		Gain Select>1.8V, V _{PD} /V _{REF} =0V
Output VSWR			2:1		
Current Drain		7.5	10.0	mA	
<i>BYPASS MODE</i>					
Gain	-3	-2	-1	dB	
Input IP3	+10	+24		dBm	Gain Select>1.8V, V _{PD} /V _{REF} =0V
Input VSWR			2:1		
Output VSWR			2:1		
Current Drain		2.0	4.0	mA	
Cellular CDMA Driver					
Frequency	824		849	MHz	Gain Select<0.8V, V _{PD} /V _{REF} =3V
<i>HIGH GAIN MODE</i>					
Gain	14.0	15.5	17.0	dB	P _{OUT} =+4dBm, ±885kHz offset
Noise Figure		2.0	2.5	dB	
Output Power	4			dBm	P _{OUT} =+4dBm, ±1.98MHz offset
ACPR1		-65		dBc/30kHz	
ACPR2		-70		dBc/30kHz	Gain Select>1.8V, V _{PD} /V _{REF} =0V
Input VSWR			2:1		
Output VSWR			2:1		
Current Drain		8.5		mA	
<i>BYPASS MODE</i>					
Gain	-3.0	-2.0	-1.0	dB	Gain Select>1.8V, V _{PD} /V _{REF} =0V
Input IP3	+10	+24		dBm	
Input VSWR			2:1		
Output VSWR			2:1		
Current Drain		2.0	4.0	mA	
Power Supply					
Voltage (V _{CC})		3		V	High Gain mode. Select<0.8V, V _{PD} /V _{REF} =3V
V _{SELECT} Low			0.8	V	
V _{SELECT} High	1.8			V	
Power Down	0		10	µA	Low Gain mode. Select>1.8V, V _{PD} /V _{REF} =0V Gain Select<0.8V, V _{PD} /V _{REF} =0V, V _{CC} =0V

Bypass Possibility

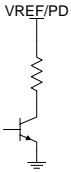
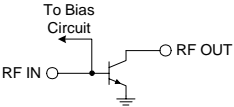
Gain Select	V_{PD}/V_{REF}	V_{CC}	Current	Comments
>1.8V	0V	3V	2.3mA	Recommended Bypass Mode
>1.8V	3V	3V	3.4mA	Alternative Bypass Mode

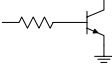
Pin	Function	Description	Interface Schematic
1	VREF/PD	For low noise amplifier applications, this pin is used to control the bias current. An external resistor can be used to set the bias current for any V_{PD} voltage.	
2	GND1	Ground connection. For best performance, keep traces physically short and connect immediately to ground plane.	
3	RF IN	RF input pin.	
4	RF OUT	Amplifier output pin. This pin is an open-collector output. It must be biased to V_{CC} through a choke or matching inductor. This pin is typically matched to 50Ω with a shunt bias/matching inductor and series blocking/matching capacitor. Refer to application schematics.	
5	GND2	LNA emittance inductance. Total inductance is comprised of package+bondwire+stripline (L1) on PCB.	
6	SELECT	This pin selects high gain and bypass. Select $\leq 0.8V$, high gain. Select $\geq 1.8V$, low gain.	

Application Schematic Cellular Low Noise Amplifier ~881MHz

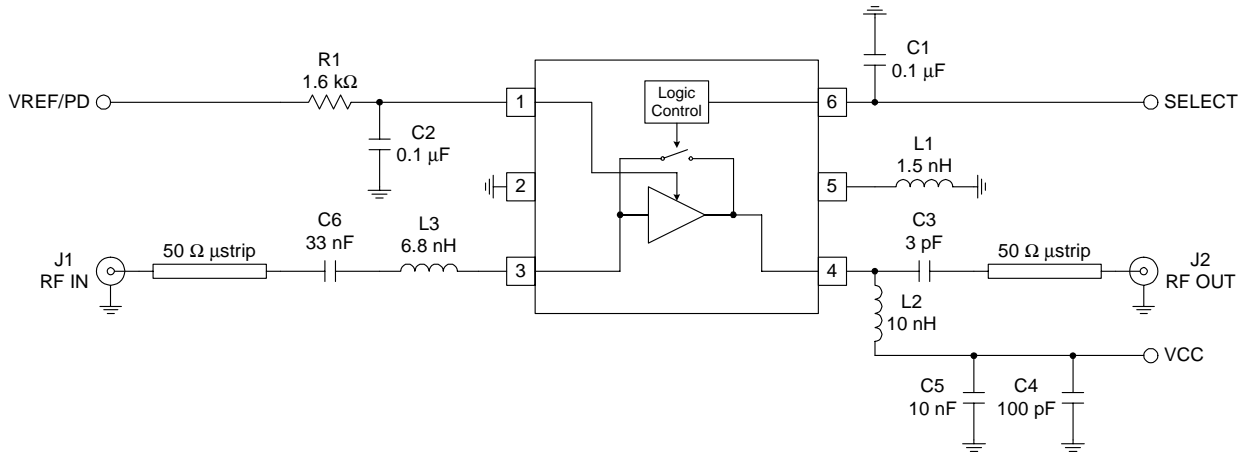

4
GENERAL PURPOSE
AMPLIFIERS

Application Schematic Cellular Driver Amplifier ~836MHz

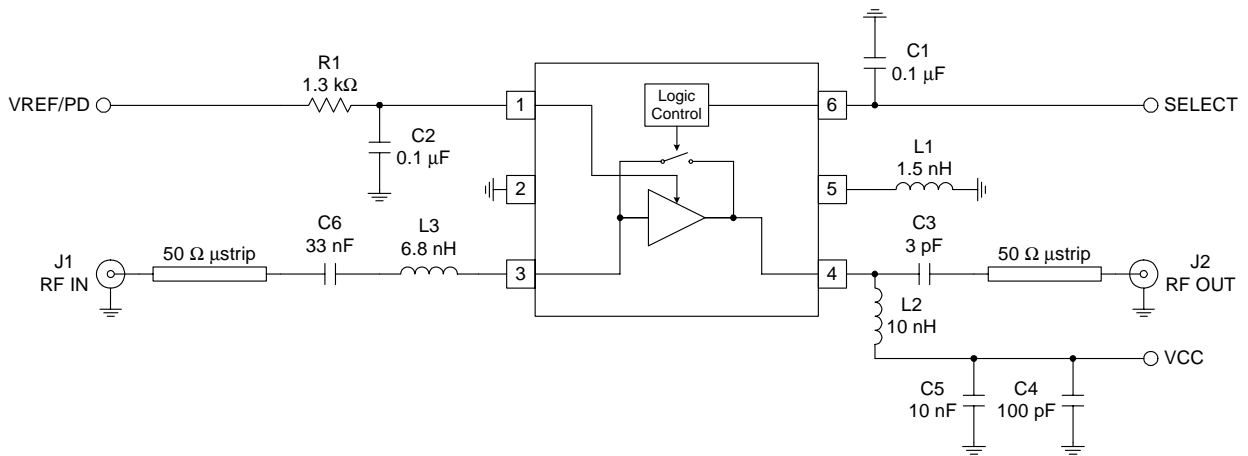

Evaluation Board Schematic - Cellular LNA

(Download [Bill of Materials](http://www.rfmd.com) from www.rfmd.com.)

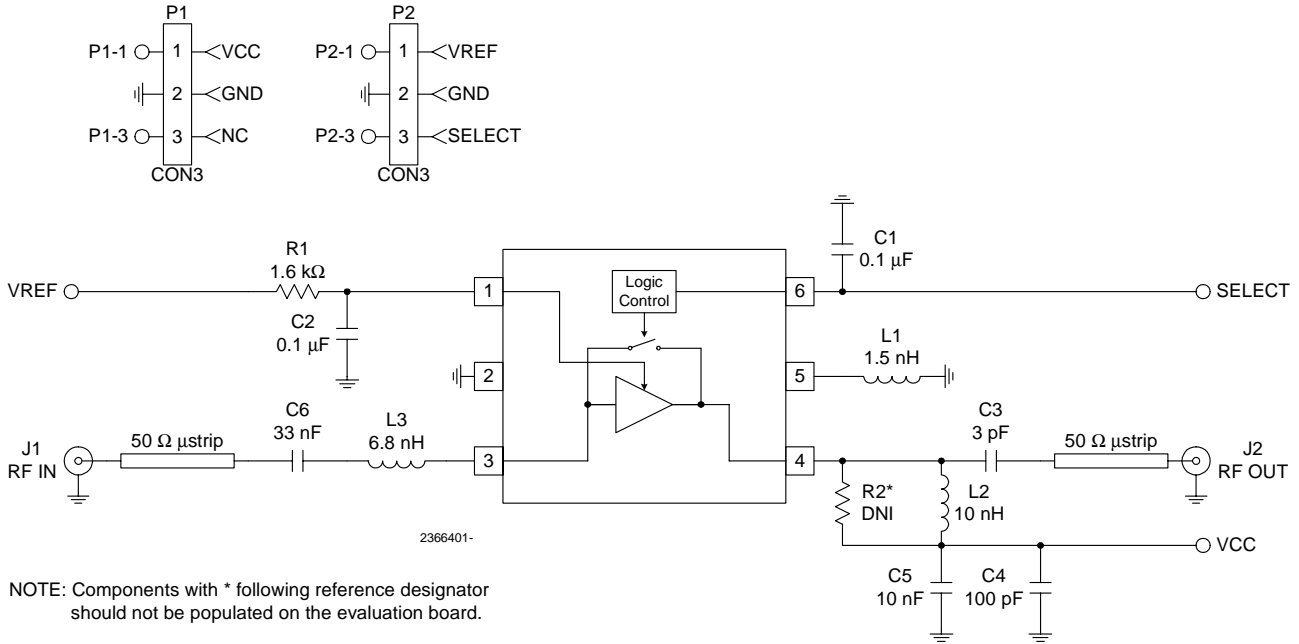

Evaluation Board Layout
Board Size 1.0" x 1.0"
Board Thickness 0.032", Board Material FR-4

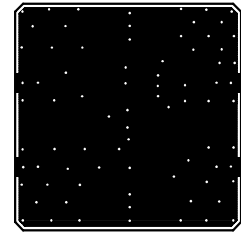
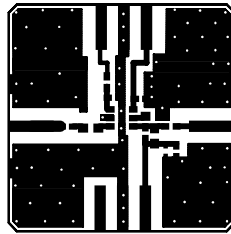
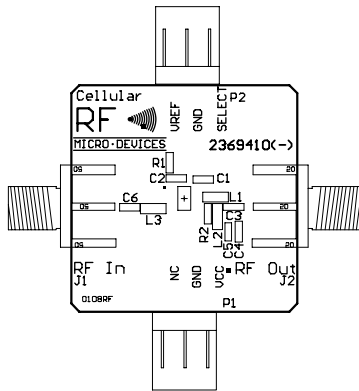

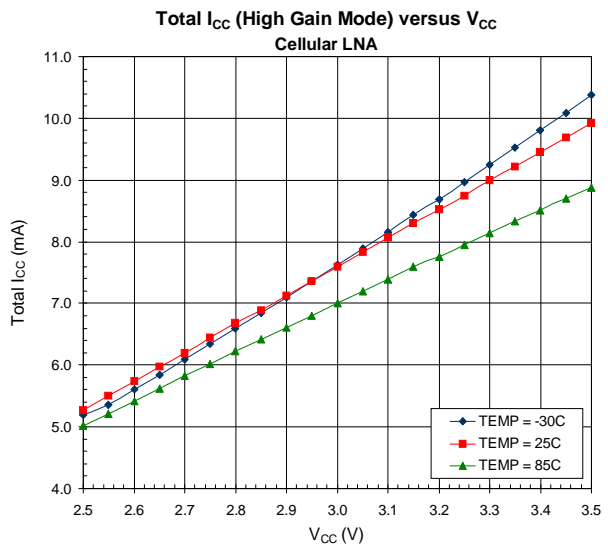
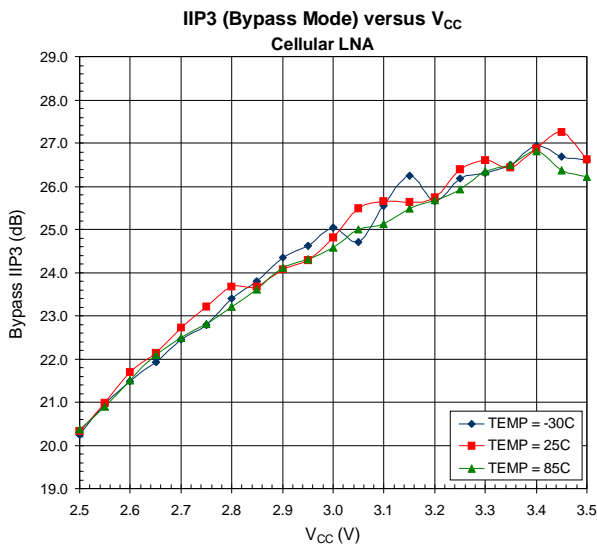
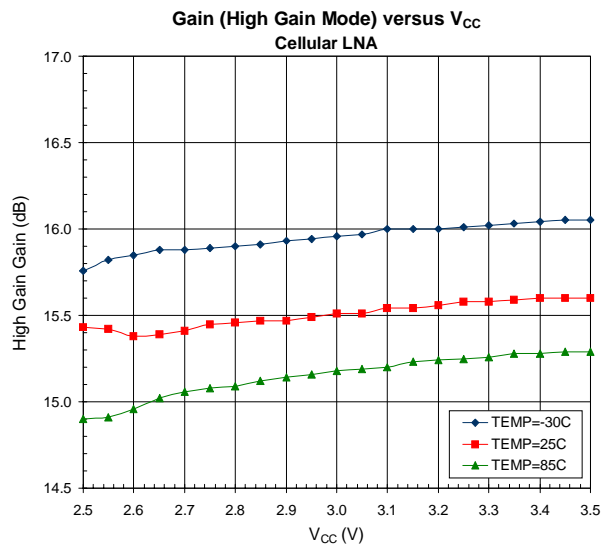
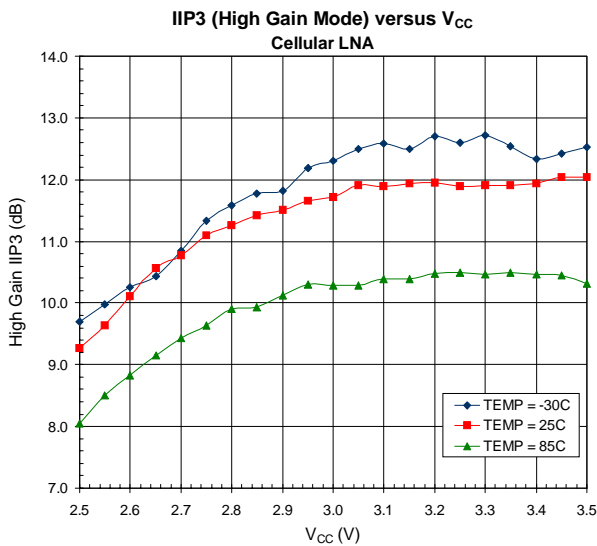
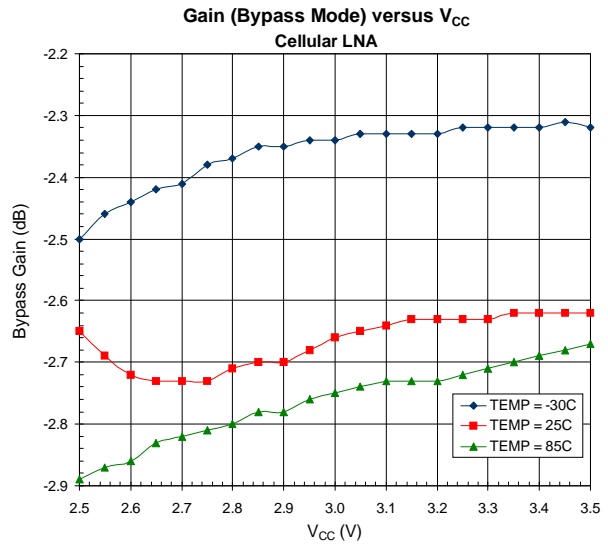
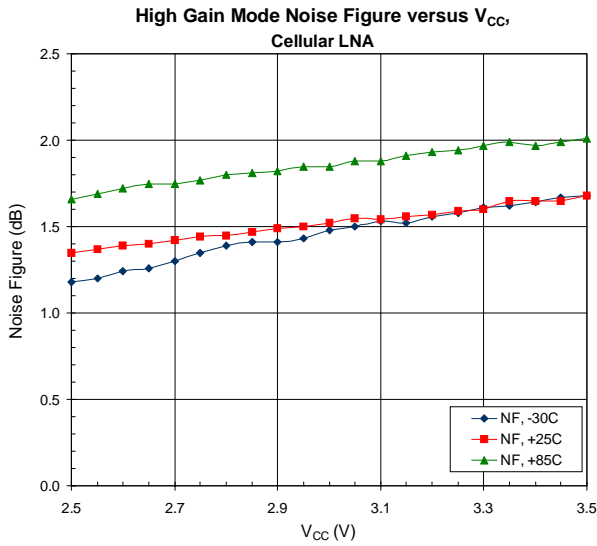

Bypass

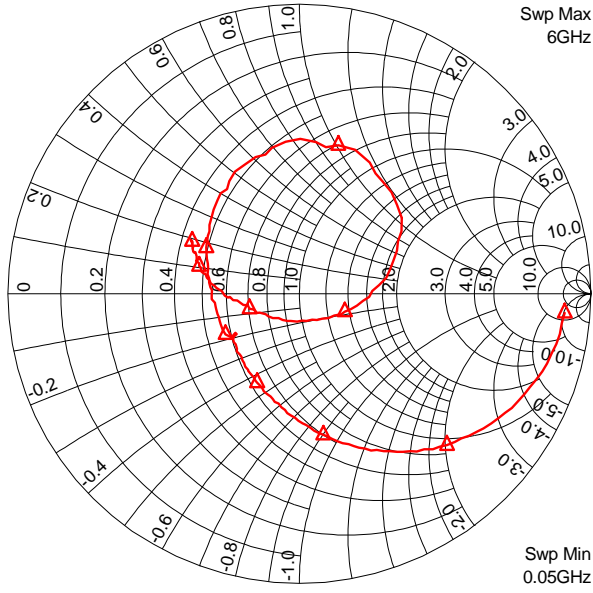

High Gain

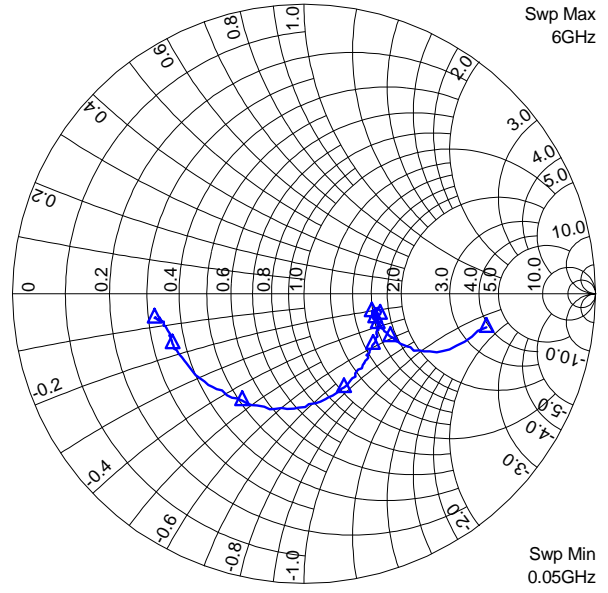

4
GENERAL PURPOSE
AMPLIFIERS

S11 Bypass Mode

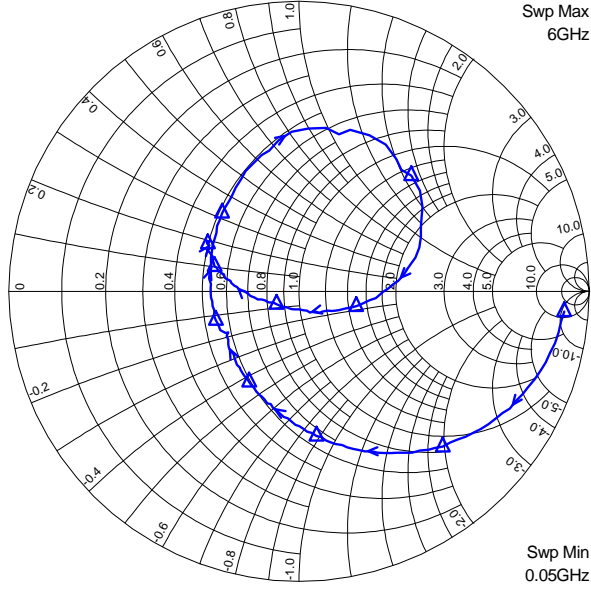

S11 High Gain Mode

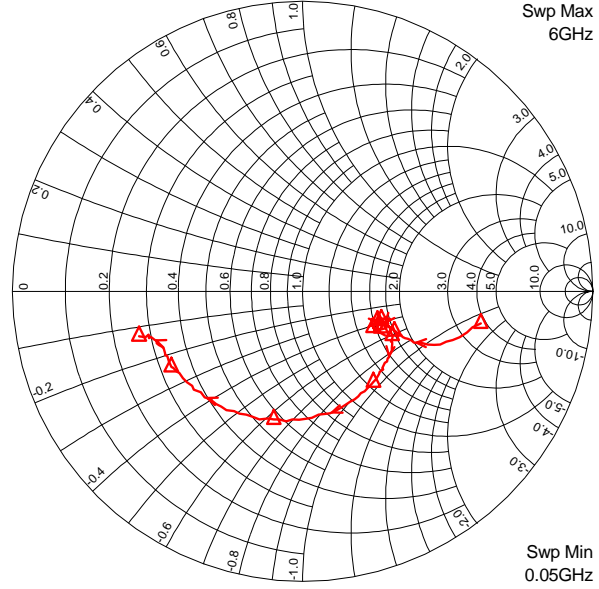

S22 Bypass Mode

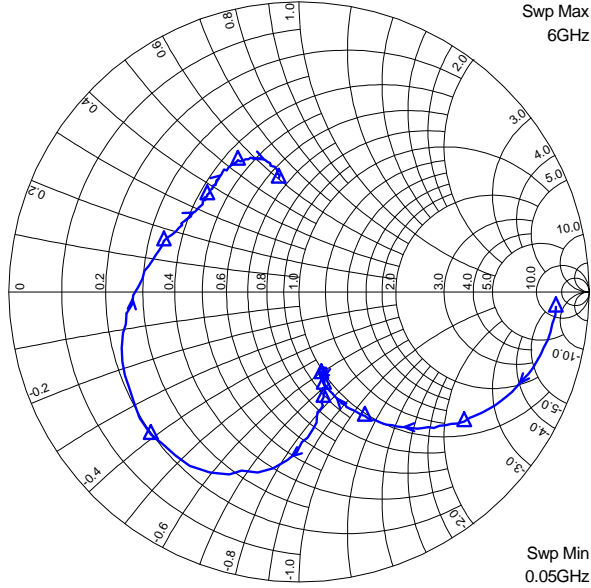

S22 High Gain Mode

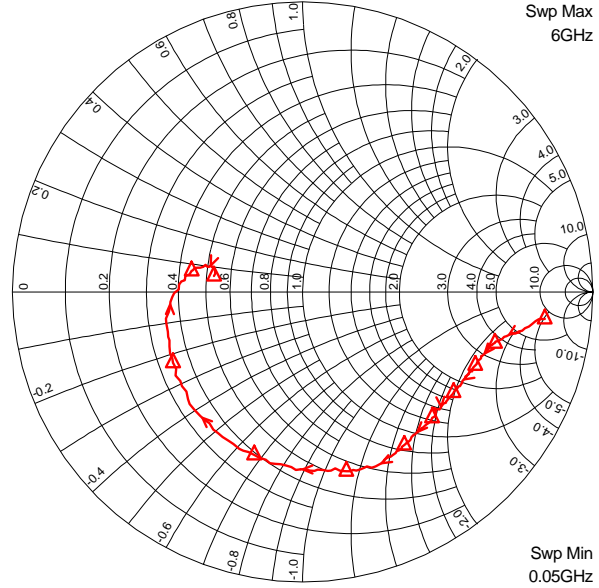

4
GENERAL PURPOSE
AMPLIFIERS